

052
40

disegnare le
trasparenze
drawing the
transparencies





OS2 40 + OS2 75

OS2 40

La massima qualità in un sistema ridotto all'essenziale.

Studiati per i progetti di interior design, i profili tubolari, agili e leggeri, riproducono nelle partizioni vetrate la stessa immagine dei serramenti OS2 a taglio termico, creando un effetto di continuità fra interno ed esterno dell'edificio.

The maximum quality in a system reduced to the essentials: OS2 40. Designed for interior design projects, the agile and lightweight tubular profiles reproduce the same image of the OS2 windows and doors in the glass partitions, creating an effect of continuity between interiors and the building envelope.



porta scorrevole con vetri singoli
sliding door with single glass



porta due ante
double sashes door







porta ad un'anima
single sash door



porta a due ante
double sashes door

OS2 40

sezioni a vista da 12 a 47 mm,
profondità di soli 42 mm e vetri
fino a 27 mm.

*the visible sections range from
12 to 47 mm while the depth is
reduced to 42 mm, for glazing
up to 27 mm.*

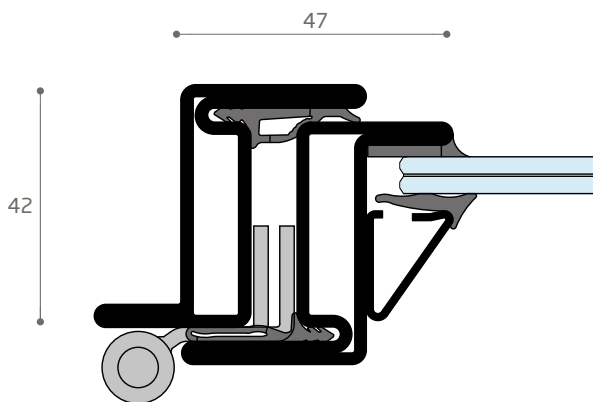

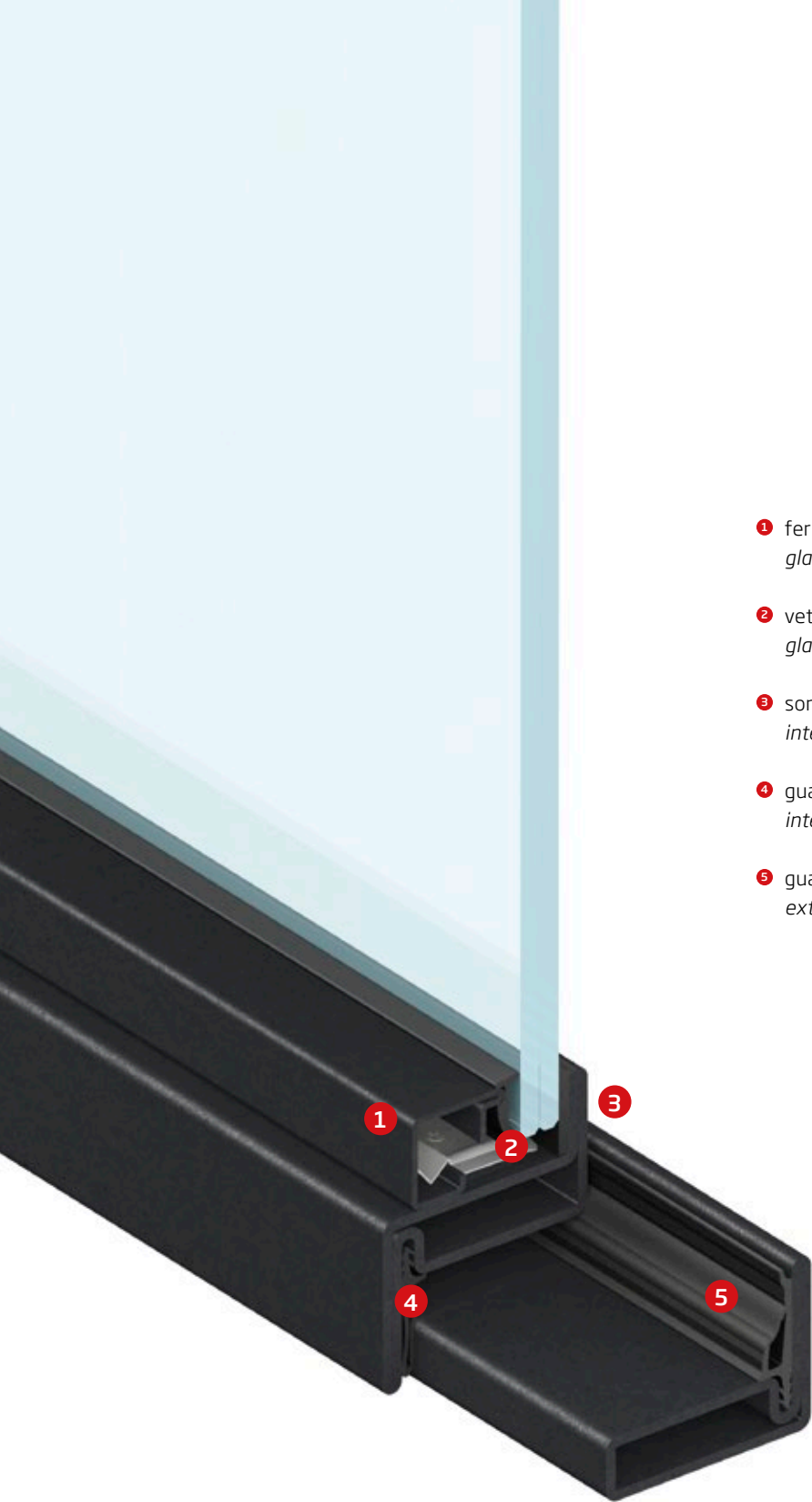

1 fermavetro
glazing bead

2 vetri fino a 27 mm
glazing slot up to 27 mm

3 sormonto interno ed esterno
internal and external overlap

4 guarnizione di battuta interna
internal rebate gasket

5 guarnizione di battuta esterna
external rebate gasket

OS2 40

tipologie di apertura porte *openings doors*

apertura interna
inward opening

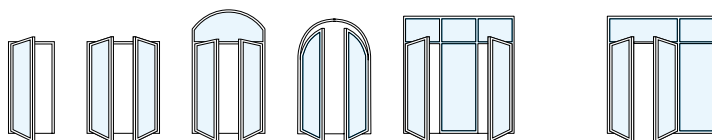

apertura esterna
outward opening

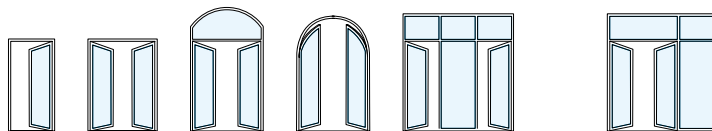

materiali *materials*

acciaio decapato
(verniciato)
pickle steel
(*painted*)

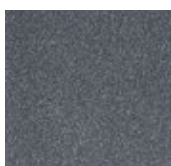

maniglie *handles*

VITRUVIO tronca

finiture
finishes

ottone naturale | brunito | verniciato
natural brass | burnished | painted

Corten
Cor-ten



VITRUVIO quadra

finiture
finishes

ottone naturale | brunito | verniciato
natural brass | burnished | painted

Corten
Cor-ten





OS2 40 vista esterna | *external view*



OS2 40 vista interna | *internal view*

OS2 40

nodi *sections*

apertura interna
inward opening

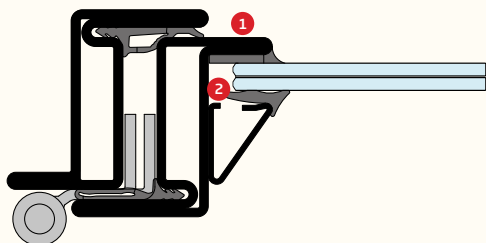

- 1 sormonto interno ed esterno
internal and external overlap
- 2 camera per vetri fino a 27 mm
fitting groove up to 27 mm

apertura esterna
outward opening

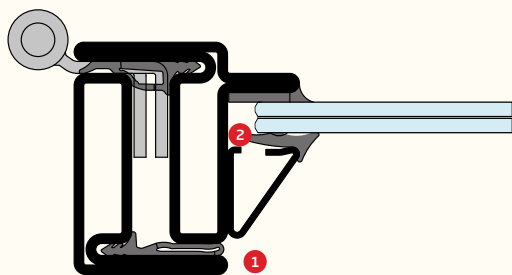

- 1 sormonto interno ed esterno
internal and external overlap
- 2 camera per vetri fino a 27 mm
fitting groove up to 27 mm

profili *profiles*

PR2424

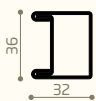

PR2425

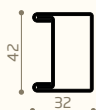

PR2430



PR2431



PR2451

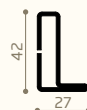

PR2461



PR2462

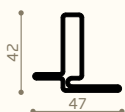

PR2463

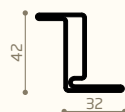

PR2464

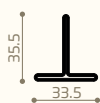

PR2471



PR2454

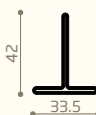

PR2455

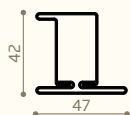

PR2474

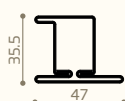

PR2482

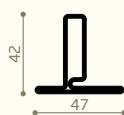

fermavetri *glazing beads*

PR2415



PR2416



PR2429



PR2606



PR2607



OS2 40

sezioni sections

apertura interna
inward opening

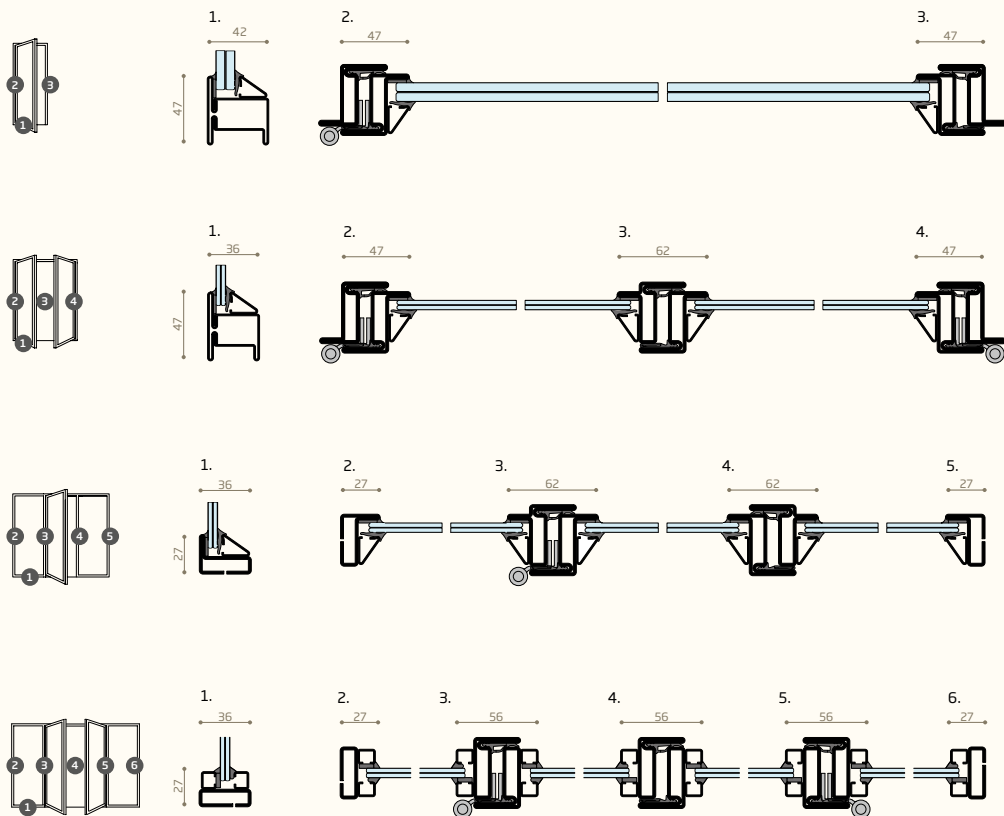

sezioni sections

apertura esterna
outward opening

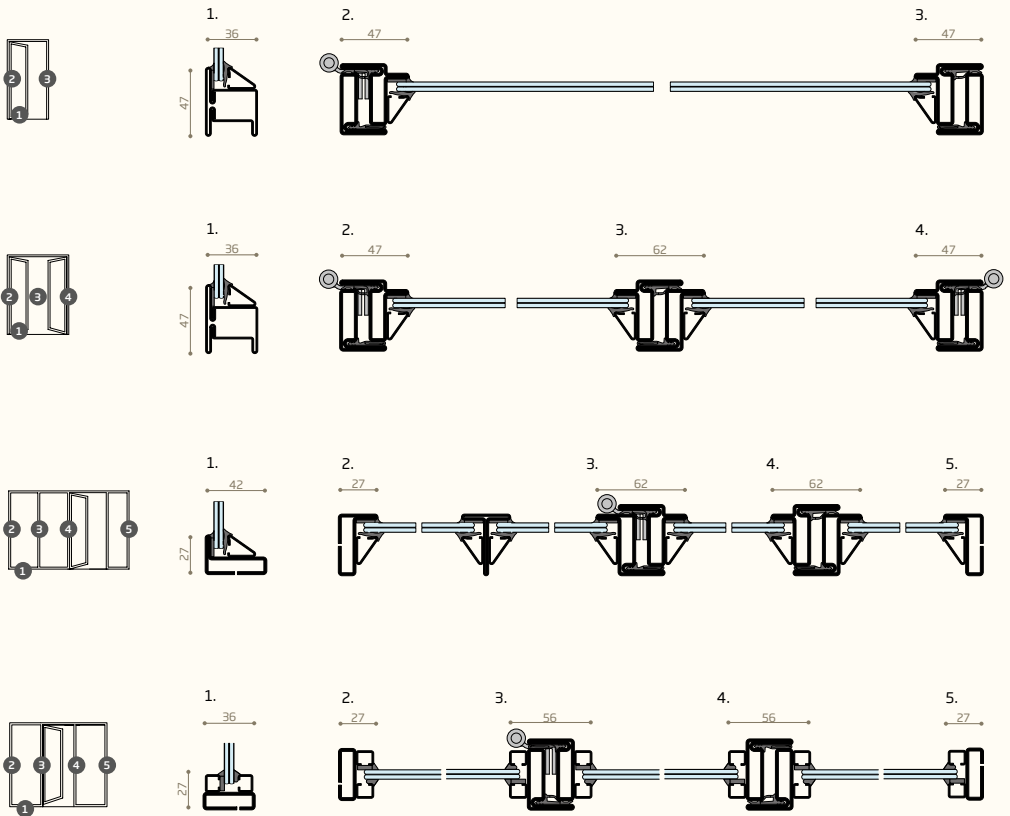







porta ad un'anta con fissi
single sash door with fixed pane



fisso con dividivetro
fix door with divide profile

Secco Sistemi S.p.A.

www.seccosistemi.com

